





















x1 <b>8840</b> 	x2 <b>8802</b> 	x4 <b>8823</b> 	x4 <b>8817</b> 	x8 <b>3,5x13</b> 	x8 <b>4,2x38</b> 	OPCJA OPTION 		
x4 <b>8830</b> 	x2 <b>8870</b> 	x4 <b>8920</b> 	x1 <b>8850</b> 	x1 <b>8880</b> 	x1 <b>0099</b> 	x1 <b>0091</b> 	<b>8212</b> 	<b>8176</b> 

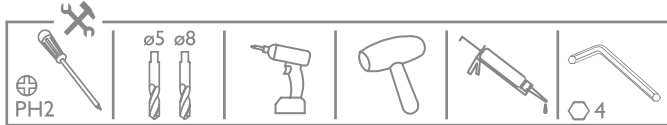
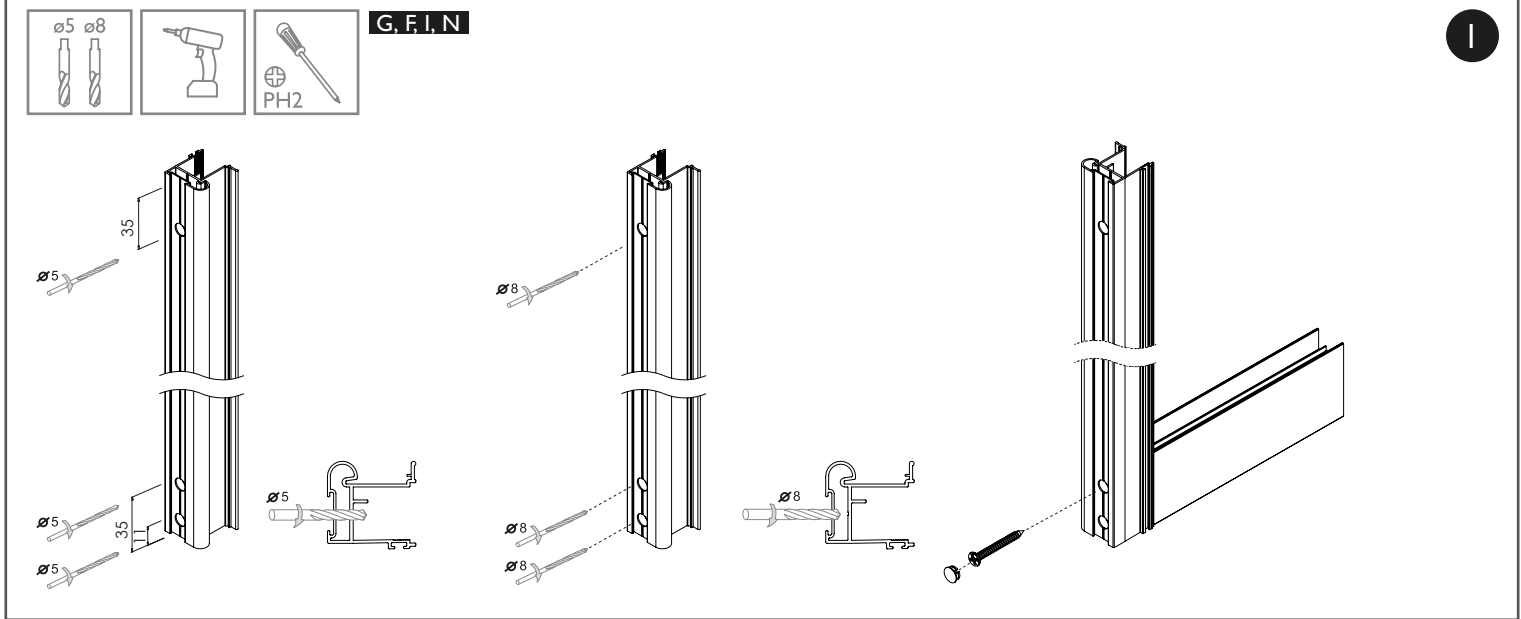
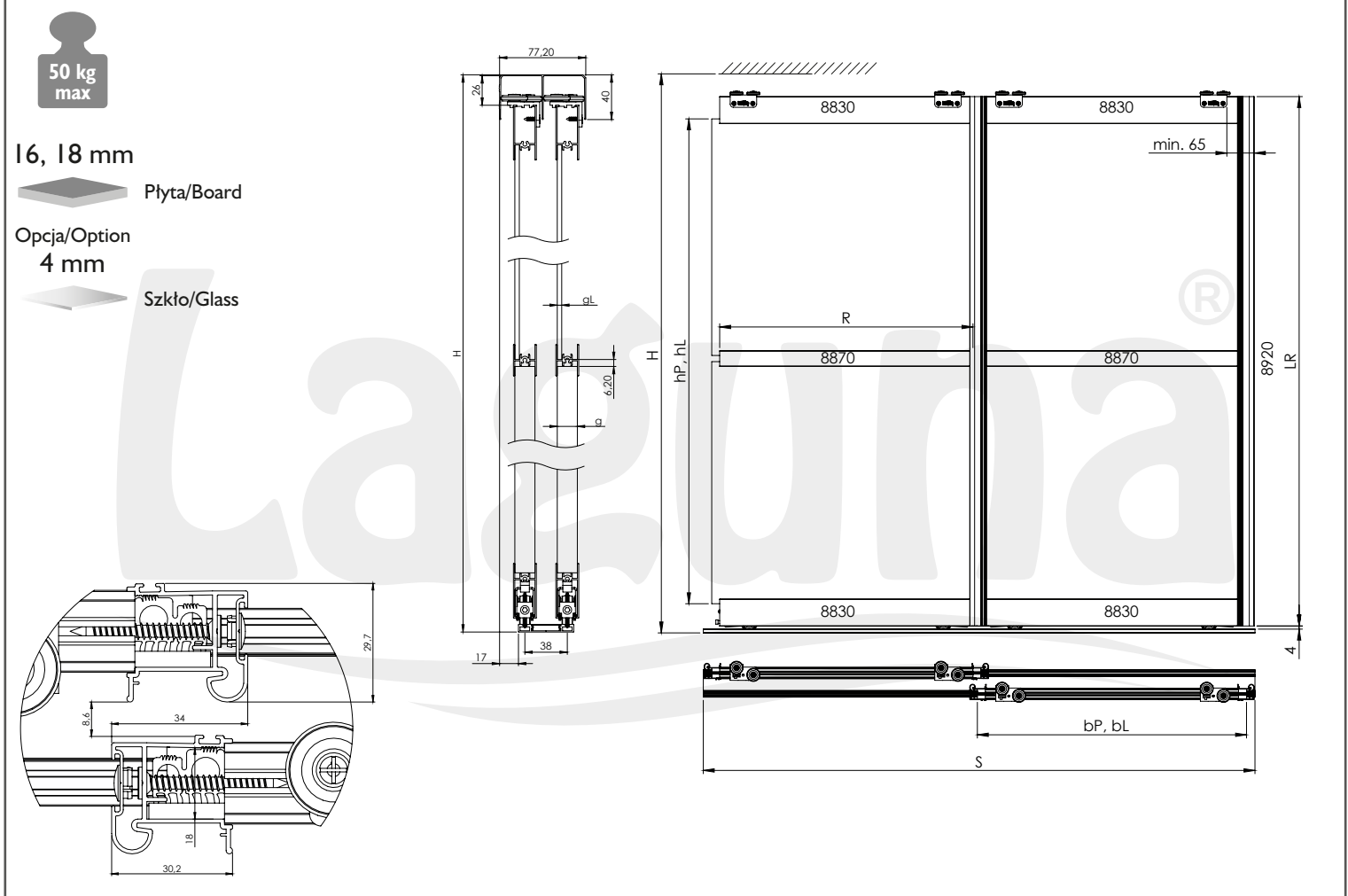

# RAMA WIDE

na torze RAMA  
lower track RAMA



	Liczba skrzydeł n / Quantity of doors n	n = 2	n = 3	n = 4	n = 5	n = 6	n = 7	n = 8
 18 mm	Wysokość płyty hP [mm] / Board height hP [mm]	hP = H-121						
	Szerokość płyty bP [mm] / Board width bP [mm]	$bP = (S-21)/2$	$bP = (S-15)/3$	$bP = (S-8)/4$	$bP = (S-2)/5$	$bP = (S+4)/6$	$bP = (S+11)/7$	$bP = (S+17)/8$
	Długość ramiaka dolnego, górnego oraz łącznika R [mm] Upper, lower rail and connector length R [mm]	R = bP-29						
	Długość rączki LR [mm] / Handle length LR [mm]	LR = H-40						
 16 mm	Wysokość płyty hP [mm] / Board height hP [mm]	hP = H-121						
	Szerokość płyty bP [mm] / Board width bP [mm]	$bP = (S-21)/2$	$bP = (S-15)/3$	$bP = (S-8)/4$	$bP = (S-2)/5$	$bP = (S+4)/6$	$bP = (S+11)/7$	$bP = (S+17)/8$
	Długość ramiaka dolnego, górnego oraz łącznika R [mm] Upper, lower rail and connector length R [mm]	R = bP-29						
	Długość rączki LR [mm] / Handle length LR [mm]	LR = H-40						
 4 mm	Wysokość lustra/szkła hL [mm] Mirror height hL [mm]	hL = H-112						
	Szerokość lustra/szkła bL [mm] Mirror width bL [mm]	$bL = (S-3)/2$	$bL = (S+12)/3$	$bL = (S+27)/4$	$bL = (S+43)/5$	$bL = (S+58)/6$	$bL = (S+74)/7$	$bL = (S+89)/8$
	Długość ramiaka dolnego, górnego oraz łącznika R [mm] Upper, lower rail and connector length R [mm]	R = bL-38						
	Długość rączki LR [mm] / Handle length LR [mm]	LR = H-40						



2.1

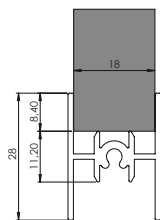

18 mm

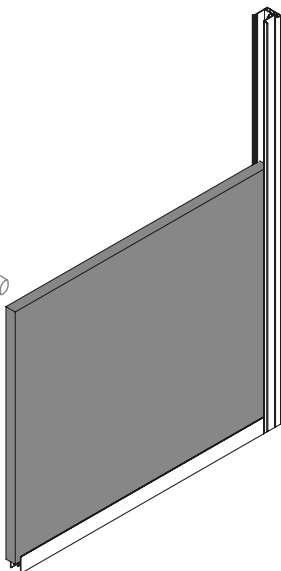

2.2



8815

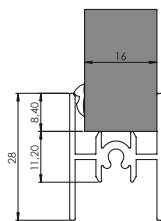

16 mm

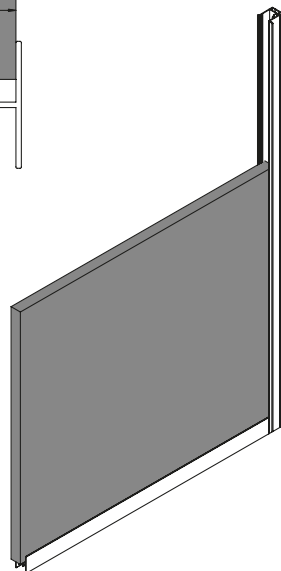

2.2



8176

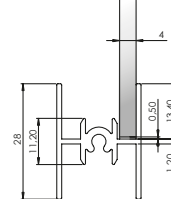

4 mm

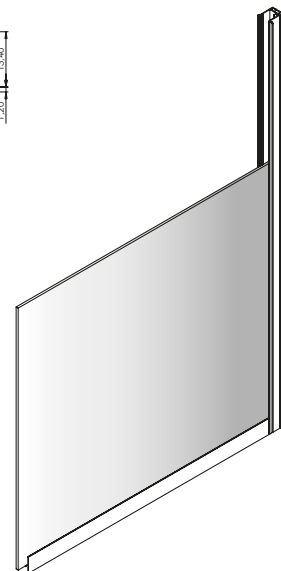

2.3

**G, H, I** **3**

**A** **B**  
**C** **D**

**F, I, N** **4**

PH2

**P** **5.1**

**5.2**

**C, D, E** **6**

PH2

4

**A, B, J** **7**

77,2

40

17

49,5

6,8

Front zabudowy

**J, K** **8**

**9**

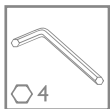

L, M

